

# Formulate 10' Straight - Kit 1

## FMLT-WS10-01

Formulate® is a collection of sophisticated, ergonomically designed exhibit booths. Formulate combines state-of-the-art zipper pillowcase dye-sublimated fabric coverings with advanced lightweight aluminum structures to provide unique design, functionality, and style. The excellence of the Formulate line of displays, hanging structures and products is simply unmatched. Stretch fabric graphics are hand-sewn, durable and dry-cleanable.



## features and benefits:

- State-of-the-art 30mm aluminum tube frame with snap button assembly
- Available as either single-sided or double-sided units
- Easy to store and ship
- Quick to set up
- Kit includes: one frame, one pillowcase graphic and one wheeled molded storage case
- Lifetime hardware warranty against manufacturer defects

## dimensions:

### Hardware

Assembled unit:  
116.69" w x 92" h x 17.72" d  
2964mm(w) x 2337mm(h) x 450mm(d)

Approximate weight (includes graphic):  
36 lbs / 16 kgs

### Shipping

Shipping dimensions:  
1 OCL case:  
56" l x 19" h x 19" d  
1422mm(l) x 483mm(h) x 483mm(d)

Approximate shipping weight (with case):  
56 lbs / 25 kgs

### Graphic

Refer to related graphic template for more information.

Visit:  
[www.exhibitors-handbook.com/graphic-templates](http://www.exhibitors-handbook.com/graphic-templates)

## additional information:

Graphic material:  
Dye-sublimated power stretch zipper pillowcase fabric

\*Backside can be upgraded to print

When included in a larger kit, a different packaging solution will be listed to accommodate all contents of the kit. Individual packaging no longer provided.

We are continually improving and modifying our product range and reserve the right to vary the specifications without prior notice. All dimensions and weights quoted are approximate and we accept no responsibility for variance. E&OE. See Graphic Templates for graphic bleed specifications.

# Included In Your Kit

Tools, Components, & Connectors



6MM HEX KEY x1

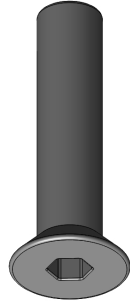

LN114-SCRW x2



WS10-T1 x4



WS10-T2 x6



WS10-T4 x1



WS10-T5 x1



WS10-T6 x2

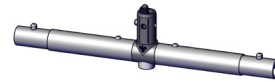

WS10-T7 x1

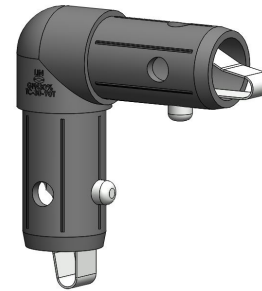

TC-30-90T x2

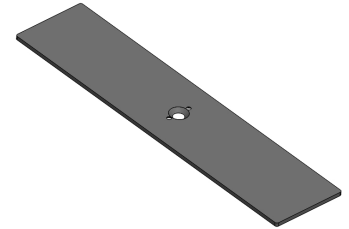

PLT-BP-LN114-S2-450 x2

Graphics

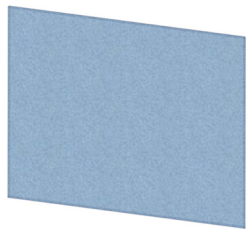

FMLT-WS10-G x1

# Exploded View

FMLT-WS10-01

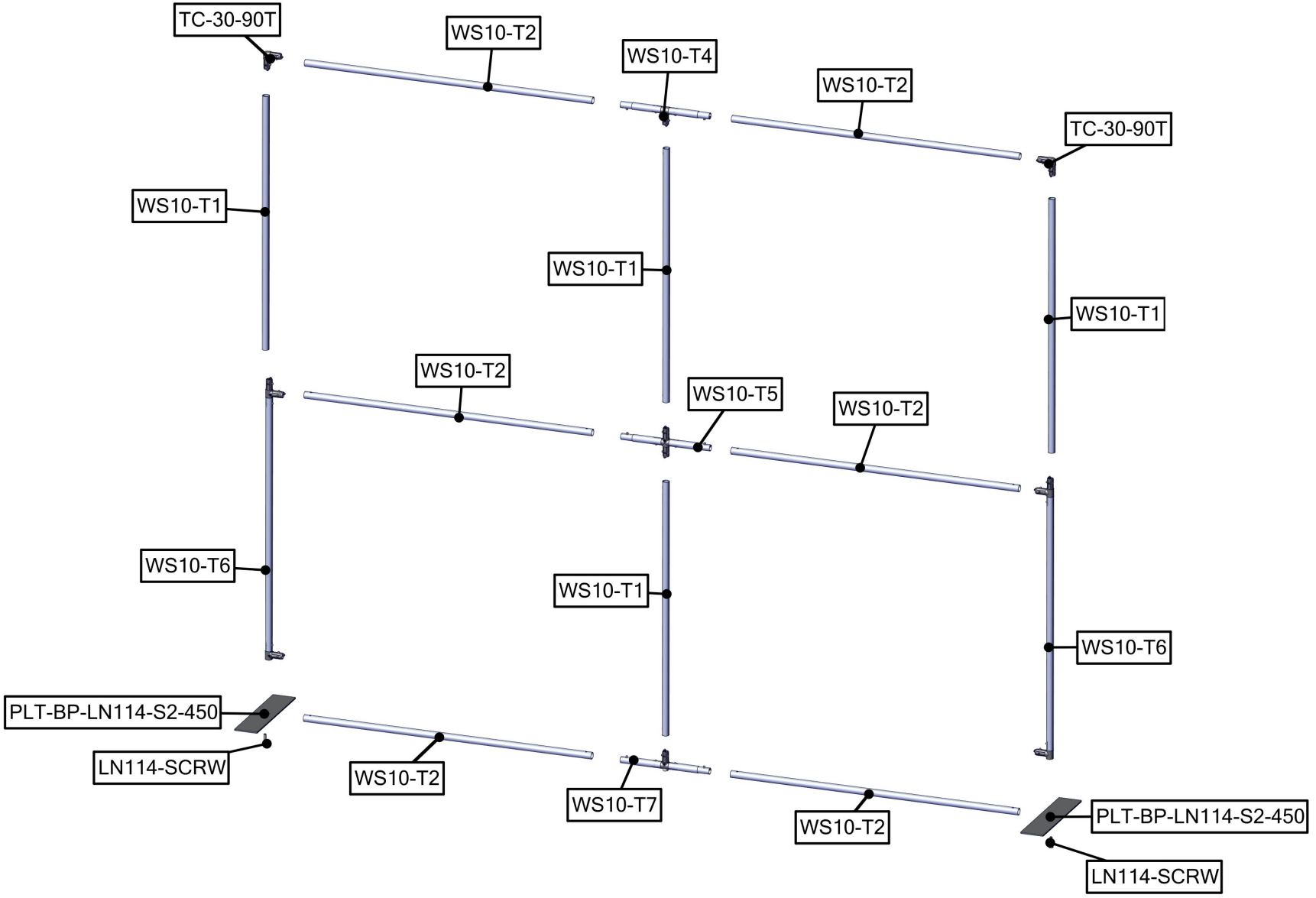

# Labeling Diagram

FMLT-WS10-01

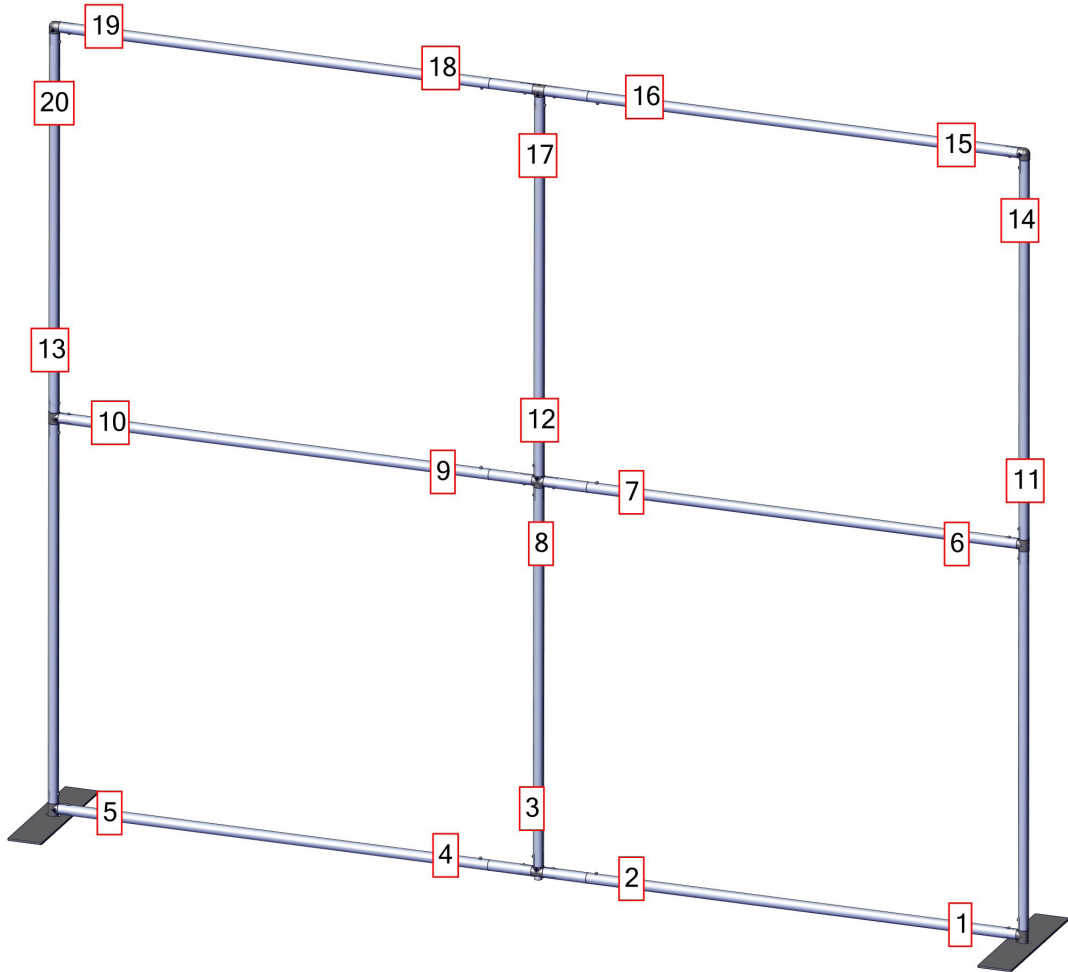

# Connection Methods

## Connection Method 1: SNAP BUTTONS

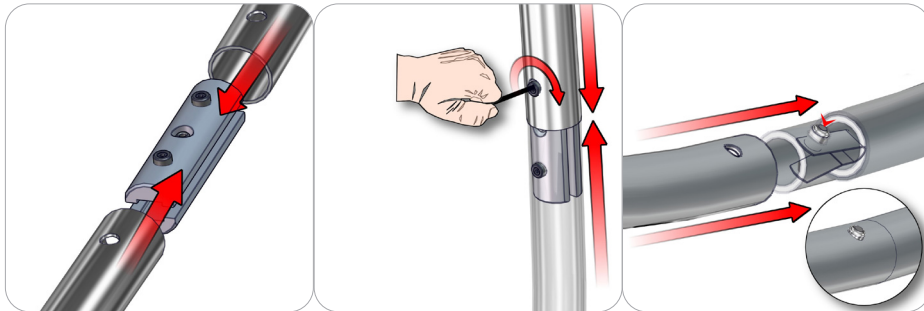

For snap button connections, locate the snap button on the connector or swage tube. Locate the hole on the corresponding tube. Press the snap button with your thumb and slide the tube and connector together so that the snap button snaps fully into the lock hole. To disassemble, press the snap button and pull apart.

## Connection Method 2: PLT-BP-LN114-S5-450

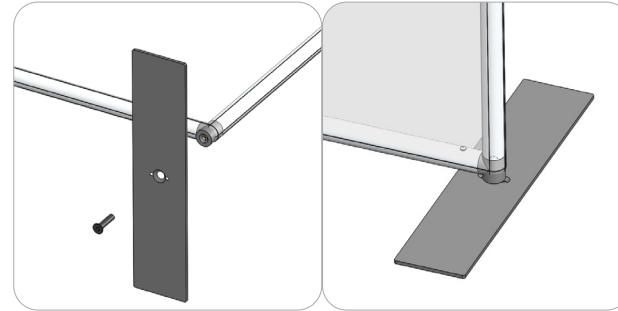

Join the frame to the stabilizing bases. Fasten the screw carefully using your allen key tool. Be sure to fasten securely, but do not overtighten.

## Connection Method 3: TC-30-90T

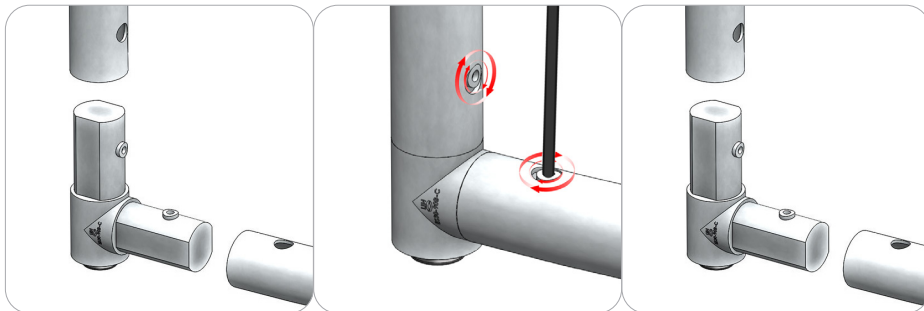

Compress one unlocked end of the connector and slide it through one tube end. Compress the other end of the connector and slide the second tube on. Lock both screws carefully using your allen key tool. Be sure to lock securely, but do not over tighten.

# Kit Assembly

## Step by Step

### Step 1.

Gather the components necessary for assembling the frame. Assemble in the order the Labeling Diagram instructs.

Please reference Connection Method 2 for more details.

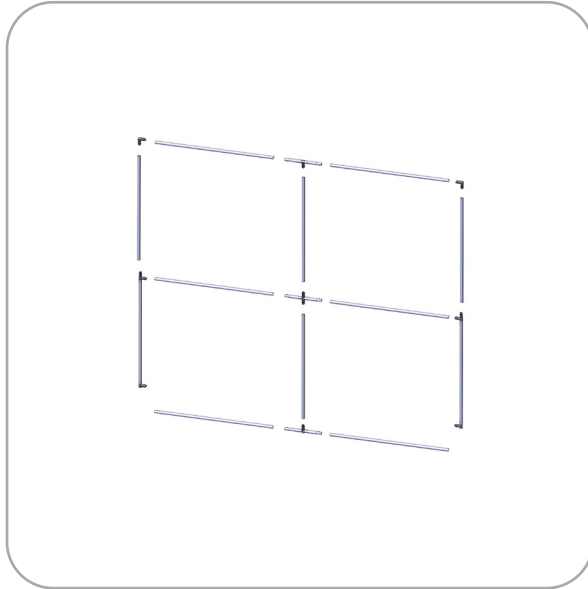
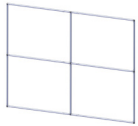

### Step 2.

Locate your pillowcase graphic. With the pillowcase unzipped, encase the frame by covering the frame from top to bottom. Zipper at the bottom.

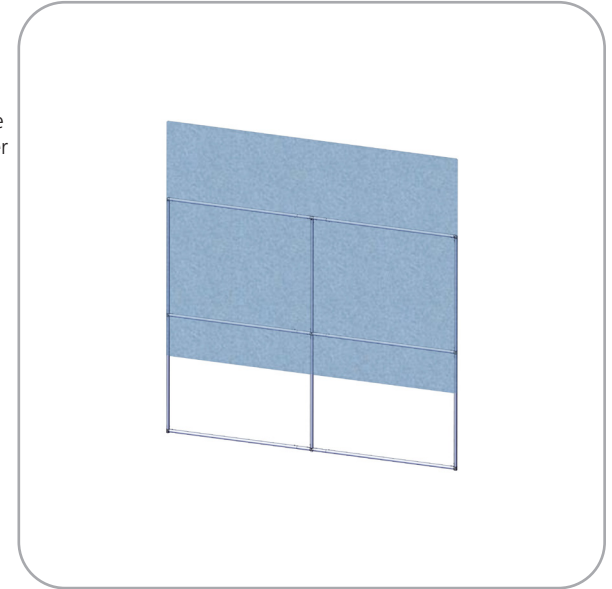
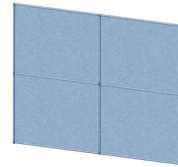

### Step 3.

Locate the stabilizing bases and screws; attach them to the bottom of the frame. Use the provided allen key tool to secure and fasten.

Setup Complete.

